

>> Original abutments enhanced.
MEDENTiKA[®] components on
original implants. <<



MPS
Multi Platform Systems

MEDENTiKA[®]
ON ORIGINAL

»» MEDENTiKA® in one sentence! Is that possible? ««

MEDENTiKA® supplies dental technicians, dentists and patients with an attractive system of precise implants and durable abutments, compatible with all popular manufacturers.

Admittedly, the sentence is a little long, but it conveys the idea behind our innovative company. Regardless of which implants from leading manufacturers individual patients already have, dentists and dental technicians usually require one assortment to work reliably, easily and efficiently. MEDENTiKA® products are not only compatible with all popular manufacturers' systems they are also less expensive - even though we manufacture all products in

Germany and Switzerland and take the job satisfaction of our employees into consideration. With MEDENTiKA®, dentists can treat their patients optimally, reliably and quickly. Dental technicians no longer have to flick through numerous catalogues and stock countless assortments. One catalogue, one assortment and one contact partner are usually sufficient.

The most important thing for us is primarily fair cooperation. This is how we have thought since the foundation of MEDENTiKA®. This is also how we will form partnerships in the future: on equal terms, openly and completely transparent.

Anyone who meets MEDENTiKA® personnel will get to know a team. A team that since the foundation of the company collectively contributes knowledge and experience. A team that perfects products with élan – on a daily basis and with passion.

We'd like to begin with an open word: With all of our strategies, undertakings and developments we have had no greater a concern than your freedom of choice with a transparent price policy! This is exactly what we are providing. You always have the choice: Do you want to be dependent on a system? Or are you ready for an alternative, which is constantly compatible, very precise and also economically sound?

We manufacture extremely precise and durable abutments in-house, which are compatible with all popular manufacturers as well as four of our own implant systems. We do this to the highest technical level, as we would like to ensure that things last. With this we mean not only our precision components but also our mutual business relationships, your economic freedom and ultimately the health and wellbeing of the patient.



»» Am I **on the safe side** legally with MEDENTiKA® products? ««

MEDENTiKA® prosthetic components and abutments allow users to be flexible in implant prosthetics and cater to all popular systems. This facilitates treatment, in particular in the case of patients with different implants.

Dr. Karl-Heinz Schnieder, specialist lawyer for medical law, explains the legal situation.



Implant bridges or single abutments, which fit various implant systems due to matching connection geometries, facilitate treatment.

What should dentists take into consideration during combination?

The decisive factor is with which products the individual system components may be combined according to CE certification, the so-called intended purpose of the respective manufacturer. This regulates whether and with which products the implant section may be connected. If the combination is approved by the notified inspection body and bears a CE Mark, there is no legal risk for the user.

In the event of a claim an expert opinion must prove that complications only arose due to the connection of implant and abutment element. Users can find the intended purpose in the instructions for use. Anyone who observes the intended purpose of the manufacturer can fully exploit the treatment options of new, flexible implant solutions in their practice.

As co-owner of kwm, a law firm focusing on commercial and medical law, Dr. Karl-Heinz Schnieder supports dentists and laboratories in legal issues.

The specialist lawyer for medical law and visiting lecturer at the University of Münster and SRH Hamm, Germany, was previously head of the law division at the Kassenzahnärztlichen Vereinigung (Association of Panel Dentists) Westphalia-Lippe, Germany, and is familiar with the stumbling blocks in routine daily practice.



Does the risk for dentists increase if they combine implant parts of different manufacturers?

Who is liable for what in the event of a claim?

No, the legal risks for dentists are not greater if they combine components from different manufacturers, which are approved for that purpose. It generally applies that every manufacturer is liable for faults in their product. This also applies if the product is combined with other components. If a provider recommends a combination not covered by CE certification, the provider is liable for damages according to a judgement of the Frankfurt District Court, Germany. Dentists are liable if they combine products contrary to the manufacturer's instructions or recommend a treatment measure to their patients outside the intended purpose with resulting damage.



According to the Medical Devices Directives do dentists become the manufacturer if they combine implant parts of different manufacturers?

Dentists always become the manufacturer if they combine individual components with one another. It does not matter whether these are from different manufacturers, i.e. dentists become the manufacturer according to the Medical Devices Directive if they: combine original implants with original abutments as well as if they combine original implants with MEDENTiKA® abutments. It therefore does not matter whether the components to be combined all originate from one manufacturer or from several manufacturers. It is only important that the respective products are permitted to be combined according to CE certification and intended use.

»» We supply **compatible refinements** ««

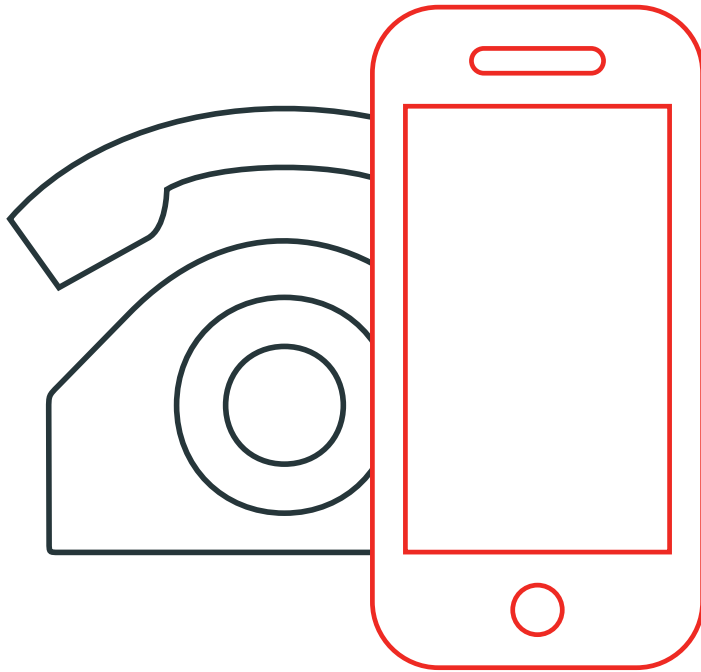

Original,
word division: origi|nal
Latin originalis = original,
to: origo (gen.: originis) =
start, source, beginning/ancestry

DUDEN (dictionary)

The word “original” comes from Latin and means “start” or “ancestry”. An original is therefore an original form, from which something derives existence and develops – our Original 2.0.

Originals are a challenge for us. It would be impractical and uninspired to simply copy a system. Originals are there to be improved and further developed. Otherwise we would still be using dial telephones today and not Smartphones. Our aim at MEDENTiKA® is to provide compatible refinements. To this purpose we analyse the designs and material quality of individual manufacturers, incorporate the practical experiences of users and optimise the design where possible. We refine the mechanical properties where necessary and increase the precision in our production.

This is how our Original 2.0 was created. Our quality standards are high. Despite this we can often manufacture our products more economically than other manufacturers. We pass on this saving in price to our customers. This may sound unusual, but our success proves us right:

More than 2 million MEDENTiKA® abutments have already been sold worldwide. Our products are now sold in over 50 countries. We are open and are very pleased with the many cooperations with large, well-known dental companies.

Pictures say more than words. Check for yourself and take a critical look at what characterises a MEDENTiKA® Original.

Quality is demonstrated most clearly in a direct comparison – and we love transparency. For this reason we have prepared photomicrographs of both our abutments and also those of the original manufacturer. The illustration reveals all design and manufacturing features.

With these photographs we want to show you that we do not simply copy, but refine, whenever possible and appropriate.

»» What does **precision** in detail mean? ««

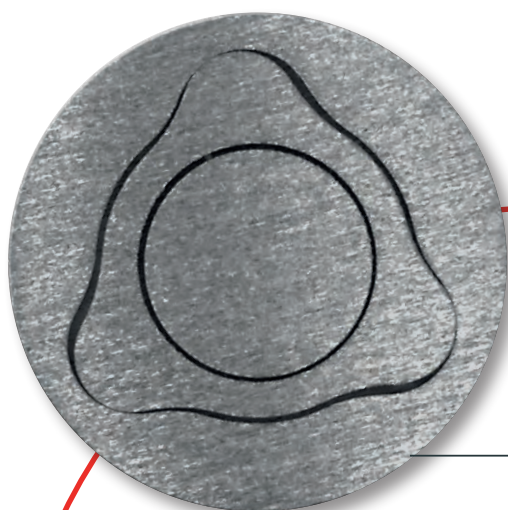

Nobel Biocare Replace Abutment

Abutment from
MEDENTiKA®



See for yourself: On the following pages you will see original implants. On the left with the fitted MEDENTiKA® abutment and on the right with the abutment of the respective original manufacturer. What do you think?

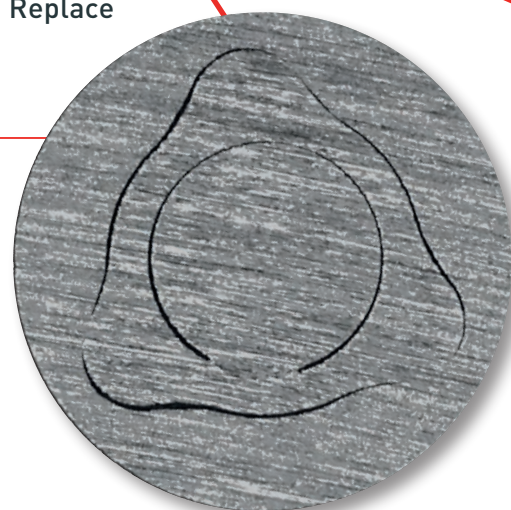

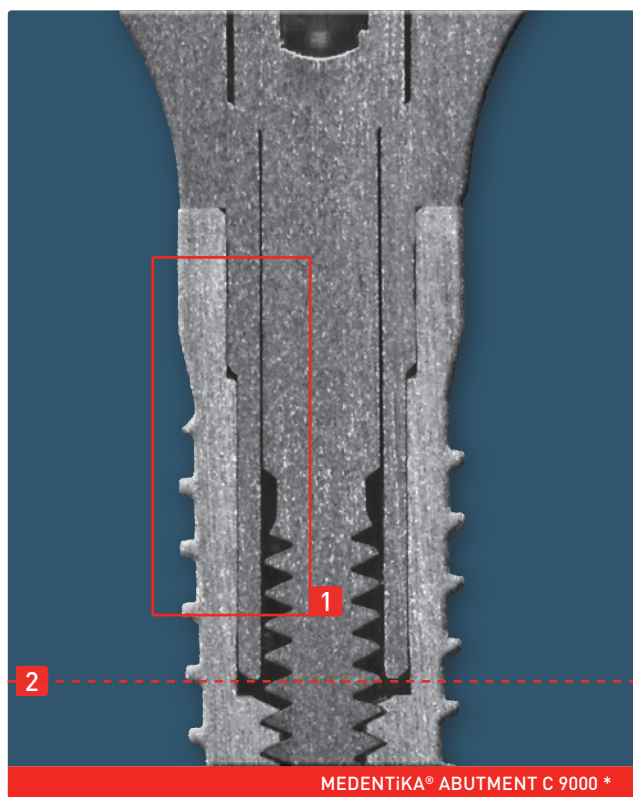
C-SERIEScompatible with **Altatec/Camlog Screw-Line – Root-Line 2**

- 1 Gap dimensions on the preliminary tube segment are practically identical to the original.
- 2 Vertical transmission of the tube segments is practically identical to the original.

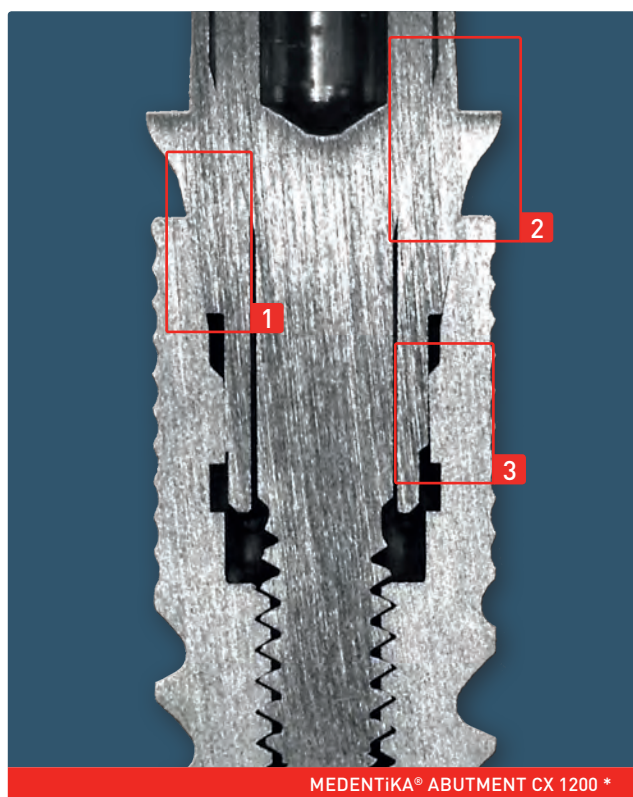
CX-SERIEScompatible with **Medentis Medical/ICX**

- 1 Highly precisely manufactured conical section with respect to full-surface contact in the vertical extension.
- 2 Emergence profile takes the physiology of the gingiva into account.
- 3 Reduced gap dimensions on the preliminary tube ensure solid absorption of the horizontal forces exerted on the abutment.

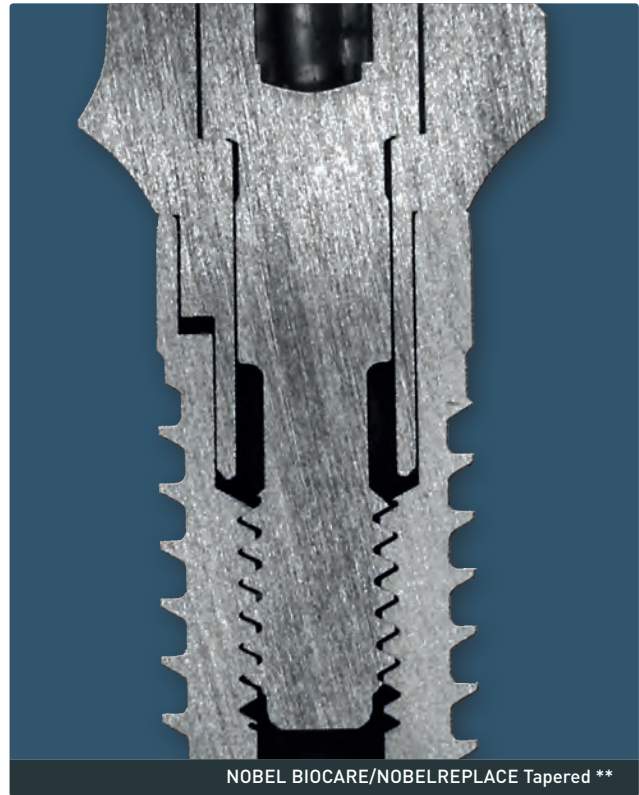
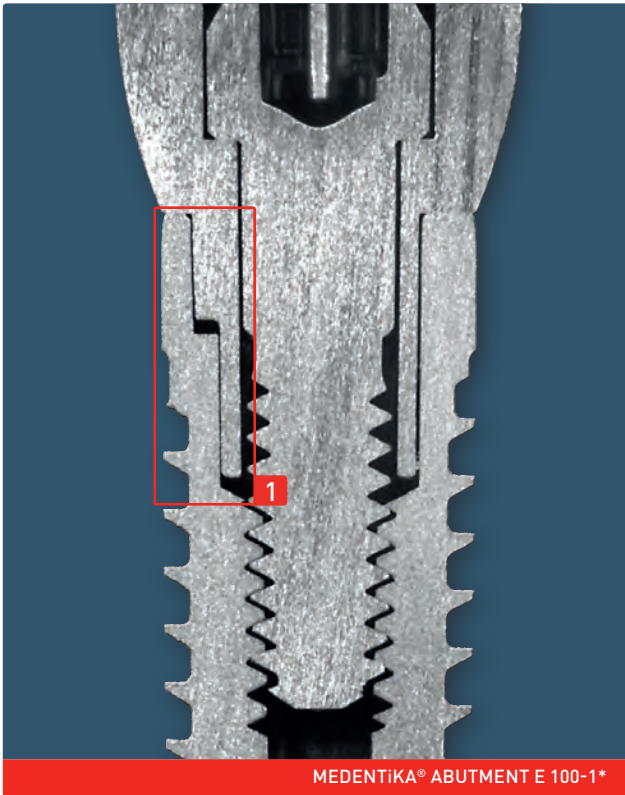

- 1 Reduced gap dimensions (see horizontal section below) on the primary cylindrical segments ensure reduced relative movements between the implant and abutment. This reduces the stress on the abutment screw and micro-pump effect of the system.

Horizontal section

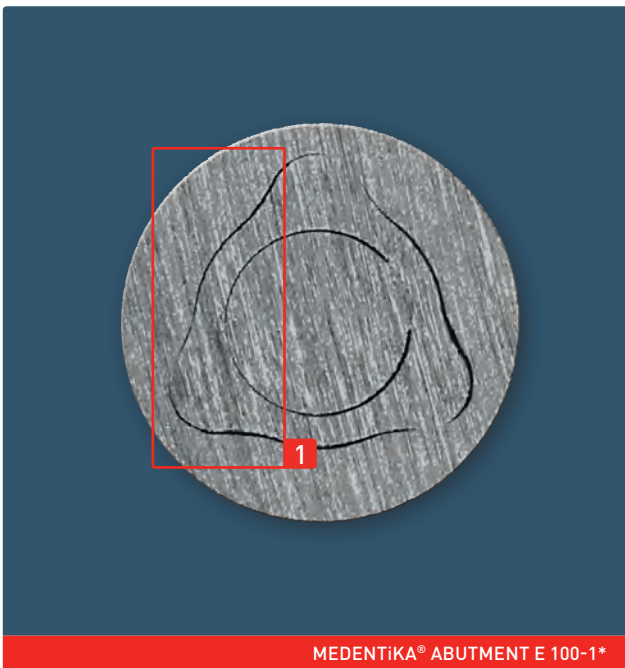

- 1 Minimised gap dimensions on the primary cylindrical segments ensure less relative movement between the implant and abutment. This minimises the stress on the abutment screw and micro-pump effect of the system.

* All MEDENTIKA® abutments are shown with the respective original implant of the manufacturer.

** All original implants are shown with the original abutment of the respective manufacturer.

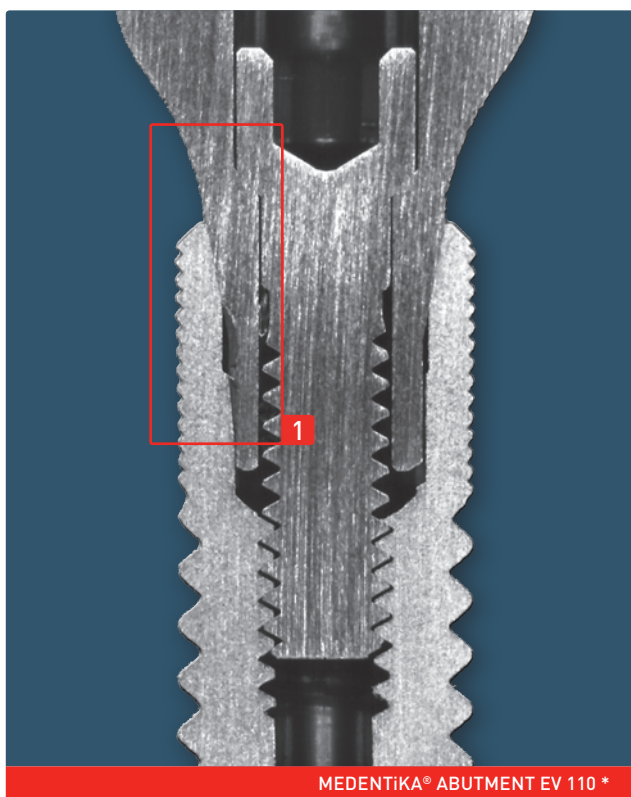
EV-SERIEScompatible with **Dentsply Implants / ASTRA TECH OsseoSpeed EV**

1 Very precise conical fit with deep transmission in the conical section.

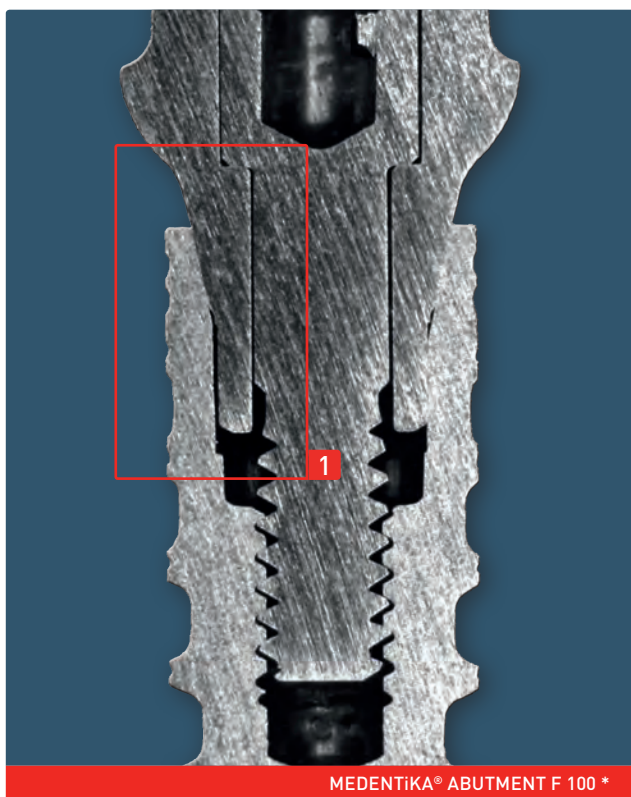
F-SERIEScompatible with **Nobel Biocare / NobelActive / NobelReplace Conical**

1 A precisely manufactured conical section guarantees full contact on the implant cone. A hex in the implant with the smallest possible gap dimensions ensures minimum rotation and axial stabilisation. A solid screw shank finally stabilises the abutment with horizontal force application.

L-SERIES

compatible with **Straumann Bone Level**

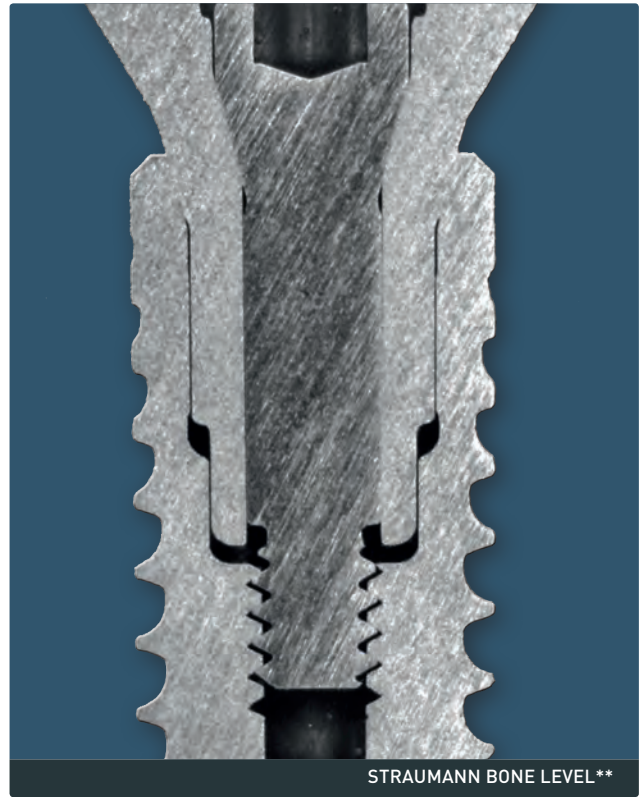
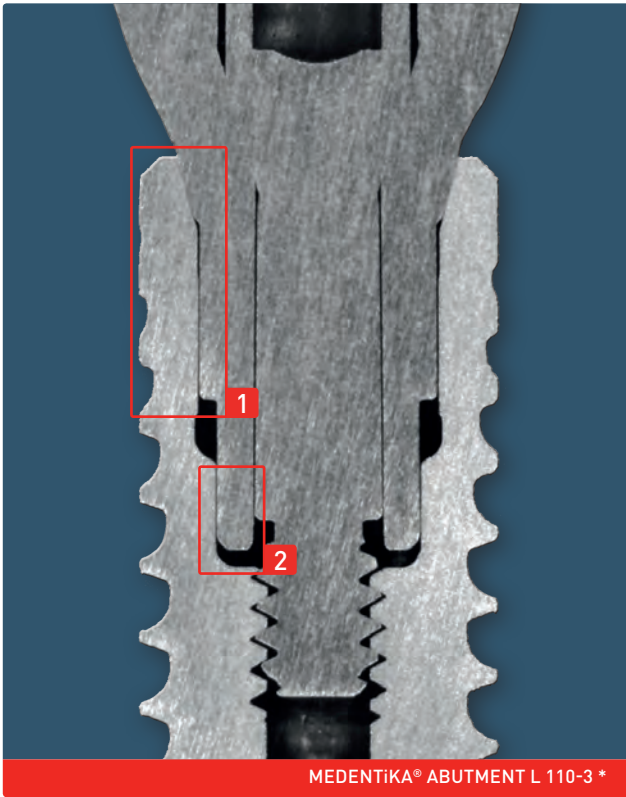

- 1 A highly precisely manufactured conical section provides full-surface contact. Reduced gap dimensions in the cylindrical element ensure high axial stability with horizontal force application.
- 2 Minimised gap dimensions provide axial stability and reduced relative movements between abutment and implant.

N-SERIES

compatible with **Straumann Tissue Level**

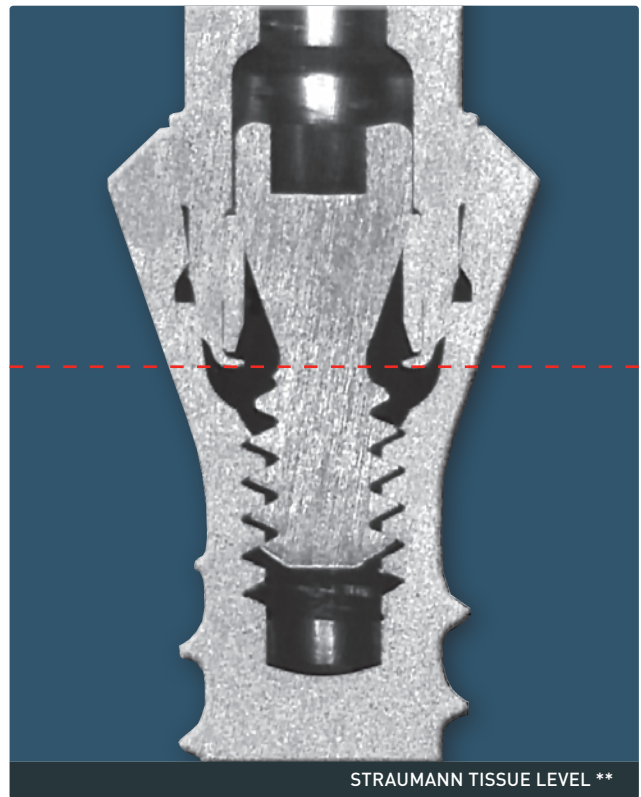
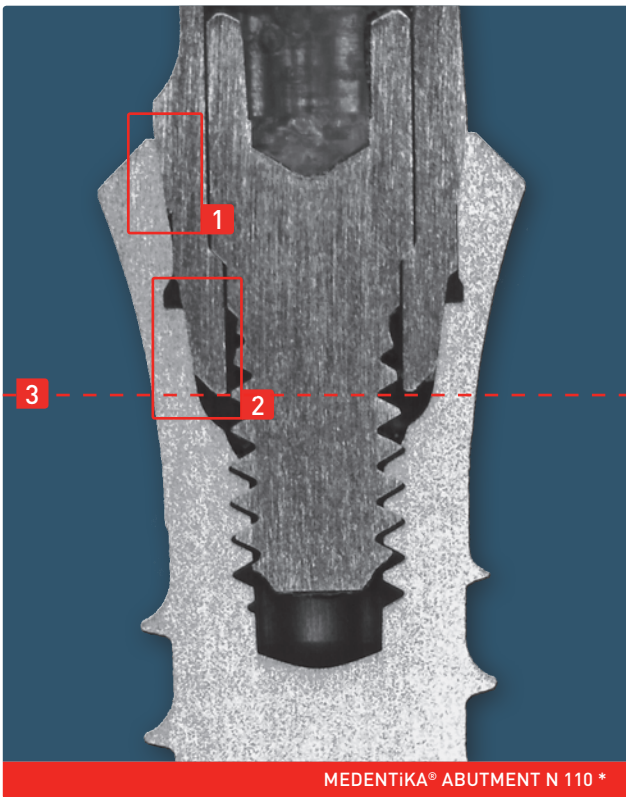

- 1 The conical fit is very precise over the entire length.
- 2+3 Conical contact is also full surface and significantly deeper in the deep conical segment. This results in considerably deeper transmission of the exerted forces in the implant.

* All MEDENTiKA® abutments are shown with the respective original implant of the manufacturer.
 ** All original implants are shown with the original abutment of the respective manufacturer.

R-SERIES

compatible with Zimmer Dental Tapered Screw-Vent/MIS SEVEN Internal Hex
BioHorizons Tapered Internal, Internal Plus, Tapered Tissue Level

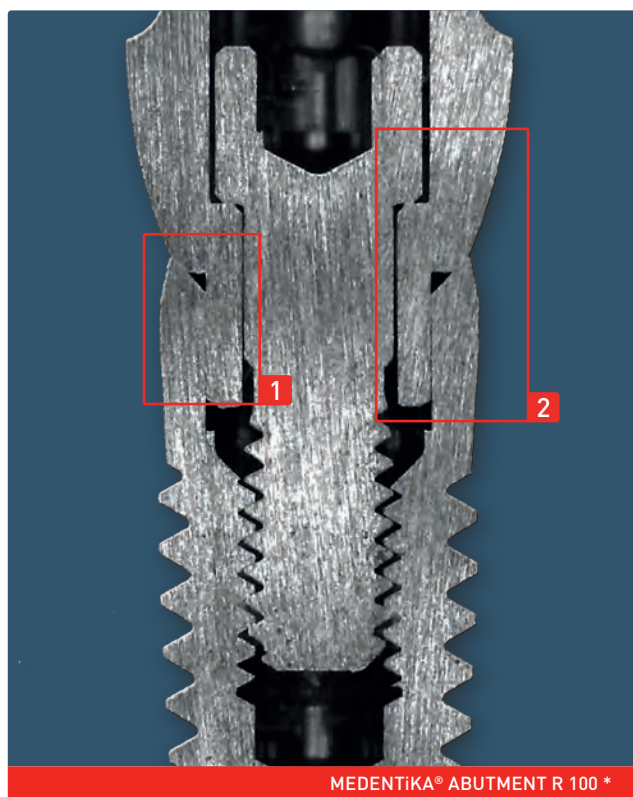

- 1 Reduced gap dimensions in the hex ensures decreased rotation and increased axial stabilisation.
- 2 Shorter, more solid abutment screw for stabilisation of the abutment by horizontal force application.

T-SERIES

compatible with DENTSPLY Implants/XiVE S

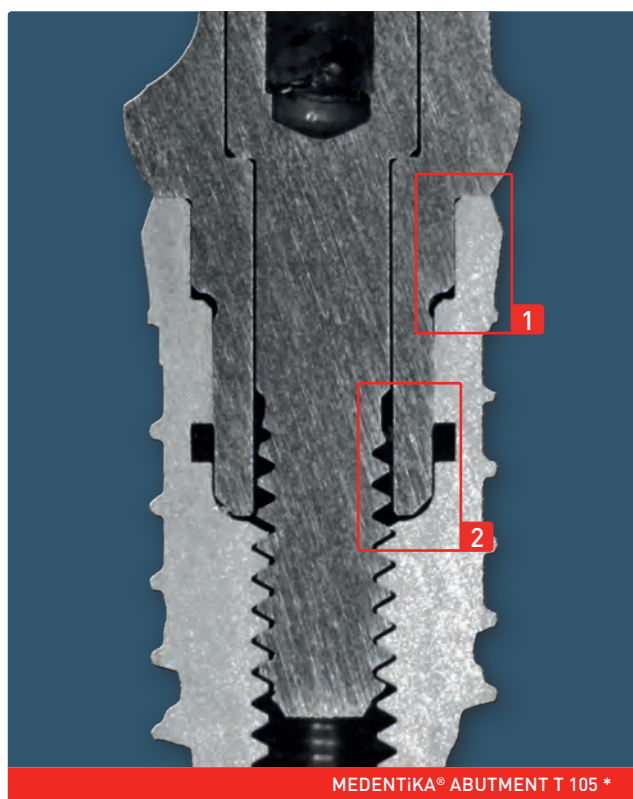

- 1 The gap dimensions in the first cylinder are minimised. This reduces the relative movements of the abutment to implant and loading of the abutment screw.
- 2 The gap dimensions have also been minimised in the second segment and ensure significantly deeper transmission. Deepest possible transmission of the forces ensures higher axial stabilisation of the abutment in the implant.

* All MEDENTiKA® abutments are shown with the respective original implant of the manufacturer.

** All original implants are shown with the original abutment of the respective manufacturer.

»» Is all **titanium** the same? ««

No. The correct quality is the decisive factor.

We also only use cold-formed Grade 5 titanium (Grade 5 CF). This material has a higher tensile strength compared with conventional Grade 5 titanium.

Ti 22

»» What do we do for quality assurance? ««

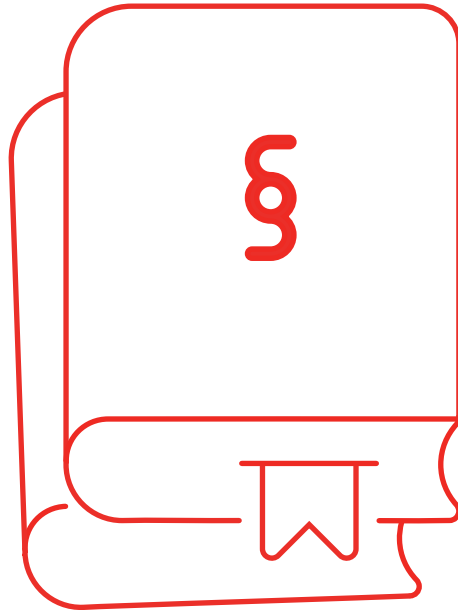

We manufacture according to the highest quality demands and fulfill the quality standards of the EU, the USA and Canada.

Creating very high quality requires people with appropriate training. An important factor is the expertise of every individual, who operates the machines and specifies how the respective processes should be executed:

The exact shape of the cutting blade. The precise setting of parameters such as cutting speed and feed rate. All this should be coordinated exactly to each individual component.

Only someone who is an expert in this area can get the best out of each machine. A very strict final inspection guarantees that every individual component that leaves our company meets that which is rightly expected of us:

MEDENTiKA® quality. We know that we achieve this quality in the location where precise craftsmanship and industrial manufacture has a long tradition: in Germany and partially also in Switzerland.

We test units and components manufactured by us on our own test machines. Why do we do this? Because we want it that way. We only supply you with products perfectly developed and produced in accordance with our analysis. You can rely on that!



Made in Germany

In a location where people work in a proven, consistent and qualified manner. All titanium and stainless steel components from MEDENTiKA® are exclusively produced in a location, where fine mechanics and maximum precision are a tradition: in Baden-Württemberg.

Our stainless steel components are manufactured by a highly specialised precision company in Switzerland.

Zertifikat

mdc medical device certification GmbH
bescheinigt hiermit, dass das Unternehmen

MEDENTiKA GmbH
Hammweg 8-10
76549 Hügelsheim
Deutschland

im Geltungsbereich

Entwicklung, Herstellung und Vertrieb von
Abutments (Aufbauten für Dentalimplantate) und
Abutmentschrauben und zahntechnischen Hilfsmitteln

ein

Qualitätsmanagementsystem

eingeführt hat und anwendet.

Ein Audit von mdc hat den Nachweis erbracht, dass dieses Qualitätsmanagementsystem
die Forderungen der folgenden Norm erfüllt:

DIN EN ISO 13485

Medizinprodukte – Qualitätsmanagementsysteme –
Anforderungen für regulatorische Zwecke

DIN EN ISO 13485:2012 - EN ISO 13485:2012 + AC:2012 - ISO 13485:2003 + Cor. 1:2009

Gültig ab 2014.03.01

Zertifikat

medical device certification GmbH
bescheinigt hiermit, dass das Unternehmen

MEDENTiKA GmbH
Hammweg 8-10
76549 Hügelsheim
Deutschland

im Geltungsbereich

Entwicklung, Herstellung und Vertrieb von
Abutments (Aufbauten für Dentalimplantate) und
Abutmentschrauben und zahntechnischen Hilfsmitteln

ein

Qualitätsmanagementsystem

eingeführt hat und anwendet.

Ein Audit von mdc hat den Nachweis erbracht, dass dieses Qualitätsmanagementsystem
die Forderungen der folgenden Norm erfüllt:

»» Are there **guarantees?** ««

YES, LIFETIME

Anyone who works with materials from MEDENTiKA® is in safe hands. MEDENTiKA® not only assumes lifetime responsibility for the quality and durability of MEDENTiKA® and MedentiCAD abutments manufactured and supplied by MEDENTiKA® but also provides a guarantee on implants of other manufacturers used with the abutment – approved by us for combination.





This extension primarily takes effect if other manufacturers limit the guarantee of their implant because it has been combined with an abutment from MEDENTiKA®.

MEDENTiKA® PRODUCTS INCLUDED
IN THE MEDENTiKA® GUARANTEE





IME

	IMPLANT	ABUTMENT
 3 years guarantee	-	MedentiLOC Abutment, replacement by an equivalent MedentiLOC abutment*.
 10 years guarantee	-	Novaloc/Optiloc Abutment, replacement by an equivalent Novaloc/Optiloc abutment*.
 lifetime guarantee	Replacement with an equivalent implant**.	Replacement with an equivalent metal abutment.
 lifetime guarantee	Refund for the external implant.	-

* except matrices and inserts, as these are subject to natural wear.

** Each guarantee case of the Minicone implant will be reviewed due to its integrated prosthetic retention system and the possible associated abrasion.

You will find our guarantee conditions on the website www.medentika.com

»» Is this not all very expensive? ««

Anyone who works together with MEDENTiKA® can have high expectations with regard to the right balance between price and performance - and of course also originality. However, in addition to the economic effects we are also concerned with the ecological and social effects of our activities.

Why are we only satisfied if we get the best possible from production? Why do we also measure products according to criteria such as environmental and social compatibility? Why do values interest us much as the job satisfaction of our employees or moral dealings, including from an economic point of view? Because we have character. And this is always very important where companies must decide: between the laws of the market and a position that puts the focus on long-term values. A characteristic feature of MEDENTiKA® is also that we believe in the power of our ideas and in our innovative strength. When the name MEDENTiKA® is printed on a package it contains more than an implant component:

We supply you with knowledge and experience, our élan, our perfectionism and our passion. Ultimately, you receive an original component manufactured with the highest precision from an extremely comprehensive prosthetic range.

You are not an abstract market for us but highly individual dental technicians and dentists with very different demands.

You deserve our endeavours; we listen to you and will continue to as long as required until we have understood what is important to you. In this way you are the central point around which we orbit. We master this core business so effectively that you can fully concentrate on your core business.



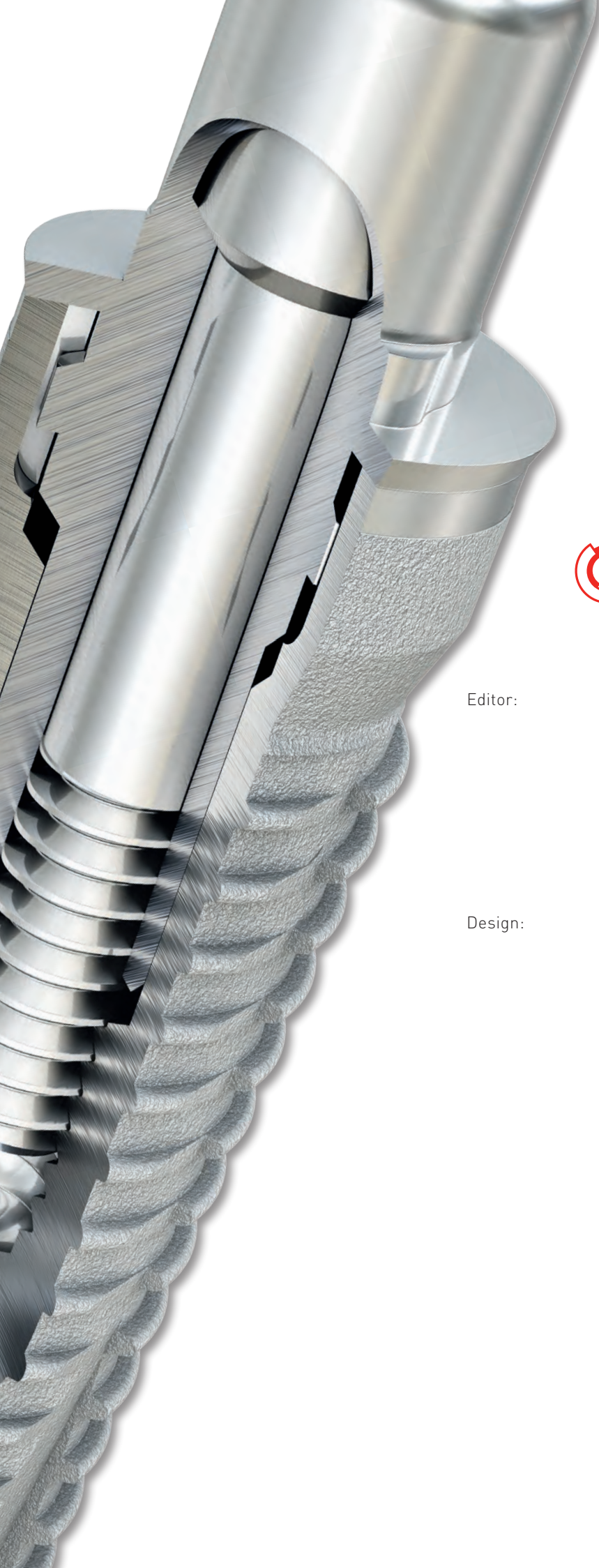

 **MEDENTiKA®**
A Straumann Group Brand

Editor: MEDENTiKA® GmbH
Hammweg 8-10
76549 Hügelshelm
Tel: +49 (0)7229 69912-10
info@medentika.de
www.medentika.com

Design: Der WeberFink GbR
graphic design studio
www.weberfink.de

As at: February 2019

We are certified:
DIN EN ISO 13485
Medizinprodukterichtlinie 93/42/EEC,
Annex II

CE0483

Technical changes and errors reserved.

You can find the Instructions for use and warranty conditions on the website www.medentika.com.

More information on the warranty can also be requested directly from the manufacturer.

MEDENTiKA® GmbH
Hammweg 8-10
76549 Hügelsheim
Germany
info@medentika.de
www.medentika.com

»» Passion for
Precision ««